

Product information

20 01 180

- Flat, short, wide jaws
- Knurled gripping surfaces
- Special tool steel, forged, oil-hardened

Flat Nose Pliers

DIN ISO 5745



General

Article No.	20 01 180
EAN	4003773042440
Pliers	black atramentized
Head	polished
Handles	plastic coated
Weight	185 g
Dimensions	180 x 56 x 13 mm
Standard	DIN ISO 5745
REACH compliant	no
RohS compliant	no

Technical details

Jaw thickness (joint) (T1)	10.0 mm
Jaw length (L3)	35.0 mm
Head width (W3)	19.0 mm

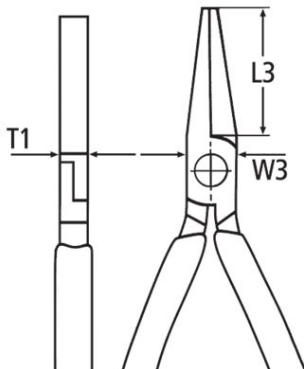

Classification	
eCl@ss 5.1.4	21040301
ETIM 5.0	EC000833
ETIM 6.0	EC000833
proficl@ss 6.0	AAA004c004
UNSPSC 13.1	27112104

technical change and errors excepted

