

Product information

20 02 160

- Flat, short, wide jaws
- Knurled gripping surfaces
- Special tool steel, forged, oil-hardened

Flat Nose Pliers

DIN ISO 5745



General

Article No.	20 02 160
EAN	4003773035008
Pliers	black atramentized
Head	polished
Handles	with multi-component grips
Weight	172 g
Dimensions	160 x 53 x 19 mm
Standard	DIN ISO 5745
REACH compliant	no
RohS compliant	no

Technical details

Jaw thickness (joint) (T1)	9.5 mm
Jaw length (L3)	30.0 mm
Head width (W3)	17.0 mm

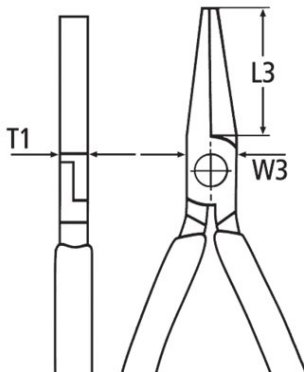

Classification	
eCl@ss 5.1.4	21040301
ETIM 5.0	EC000833
ETIM 6.0	EC000833
proficl@ss 6.0	AAA004c004
UNSPSC 13.1	27112104

technical change and errors excepted

